



LED AREA SERIES POST TOP

Adjustable power, Adjustable color temperature all in one



PRODUCT DESCRIPTION

The area series has the high-performance solution for the most demanding applications within a unique design. With different precision refractive optical lens and an easy-install design, it can be used in many applications such as pedestrian street, factory, schools, garden, courtyard, hotel, parking lot, public parks etc.

FEATURE

1. Air cooling Design
2. IP67 Rated Enclosure
3. Post top or Pendant Mounting
4. Superior Low-glare Illumination
5. Optional with Photo Cell
6. Optional Black, White or Bronze color

*If the customer does not specify a requirement, the inner diameter defaults to 62mm.

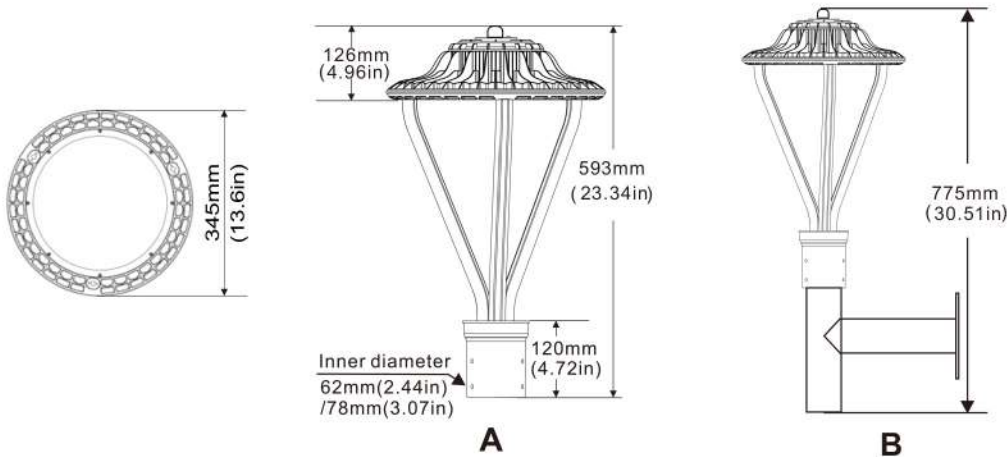

Ordering Information

Area Series	Watts	Version	CCT	Voltage	Control	Installation	Beam Angle	Color
BB-LD	30W	3in1	Blank-	Blank-100-277VAC	Blank - Photocell Sensor	Blank- 2.4"(62mm)pole	Blank-Type V	Blank - bronze
	50W		3000K	HV-200-480VAC	MS - Motion Sensor	P1- 3"(78mm)pole	T2-Type II	WH - white
	75W (all in one)		4000K				T3-Type III	BC - black
			5000K				T4-Type IV	
Optional-	5000K							
			5700K					

Notes:

1. 130lm/w, 150lm/w is optional, the default is 130lm/w.
2. Customers can choose a lamp with a baffle as needed.

Special Order-Ask Customer Service

PERFORMANCE DATA

Power	30W/50W/75W three in one
Model	BB-LD-3IN1-AR-CWT
Luminous Flux	30W=3900lm 50W=6500lm 75W= 9750lm
Replacement	30W=HPS 100W 50W=HPS 175W 75W=HPS 200W
Light Source	SMD LED
Luminous Efficacy	130lm/w 150lm/w available
Color	Bronze,Black,White(If the customer does not request, the default color is bronze)
Cover	Frosted cover
Accessories	Options: A.Pole bracke B.Wall bracket C.Wall a baffle
DLC Certification	Type A DLC Listed
Operation Temp.	-40 to +45°C
CCT	3000K/4000K/5000K All in one, Options:4000K/5000K/5700K
CRI	80+
Life Span	50,000 hours at 25°C
Voltage	100-277VAC/50-60HZ
Driver	UL listed power supply
Dimming	No
With Sensor	Daily sensor
Beam Angle	120°
IP	67
PF	>0.95
Warranty	3/5 Years



External Photocell Sensor
(Manual operation)



Built-in Photocell Sensor
(Remote control)

PROJECTS

By using our 50W Area Light to replace 150W Metal Halide bulb for parking area lighting fixtures, the customer is now able to save a lot per month from his electric bill.



Notes:

1. Don't take the LED lamp apart.
2. The LED lamp must work under the right voltage according to the specification.

APPLICATION

- Courtyard lighting
- Public parks lighting
- Street scapes lighting
- Parking areas lighting
- Hotel lighting



Street scapes lighting



Hotel lighting



Public parks lighting

Adjustable power, Adjustable color temperature controller instructions (manual operation)

- Pull out the controller cover firmly upwards. See picture 1
- Adjust the power in zone A and adjust the color temperature in zone B. The factory default power is 75W and the color temperature is 5000K. See picture 2.

Instructions for adjusting the power (zone A):

1. Adjust to 50W: pull A1 to ON, A2 to OFF, see picture 3.
2. Adjust to 30W: Pull A1 to OFF. Pull A2 to ON. See picture 4.

Instructions for adjusting the color temperature (zone B):

- 3 gears adjustment: B3=3000K, B2=4000K, B1=5000K.
The factory default is 5000K (B1). When adjusting the color temperature, just pull the button to the corresponding position.

How to use photocell sensor:

Open the photocell sensor function: remove the photocell sensor cover.

Close the photocell sensor: close the photocell sensor cover.

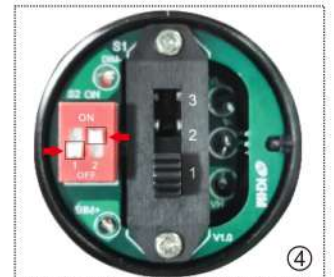
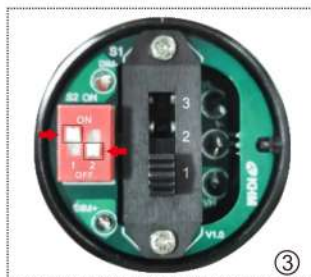
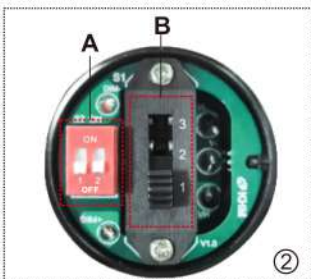
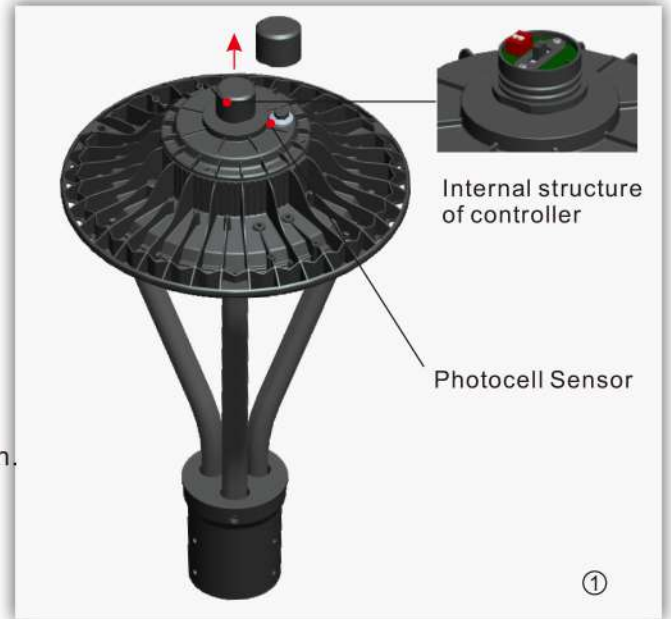

INSTALLATION

Fixture assembly

- Feed the (3) Housing wires through one of the three Rods.
- Clip the (3) Rods onto the Housing. Be sure the Housing clips are properly engaged onto the Rods.
- Feed Fixture Wires through the Tenon Pole Adaptor.
- Slide Tenon Pole Adaptor on three Rods. Be sure the notches face the inside of the Tenon Pole Adaptor.
- Tighten the (3) Set Screws at the Tenon Pole Adaptor to secure Rods.

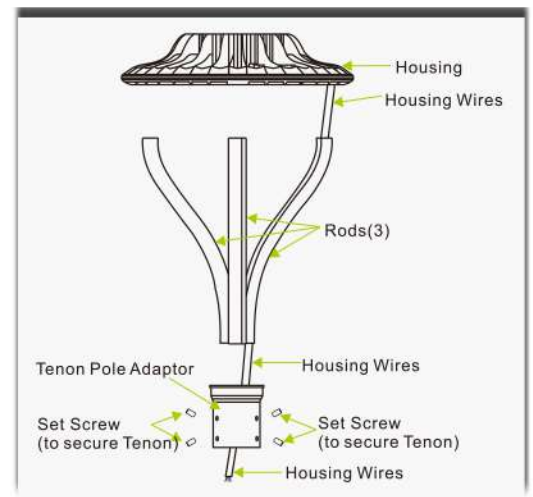

Built-in Photocell Sensor Remote Control Instructions

○ How to use the remote control:

Turning off the light will force the photocell sensor to turn on, and turning on the light will force the photocell sensor to turn off. When the power is on for the first time the light flashes once to indicate that the photocell sensor is off, and when the light is normally on, the photocell sensor is on.

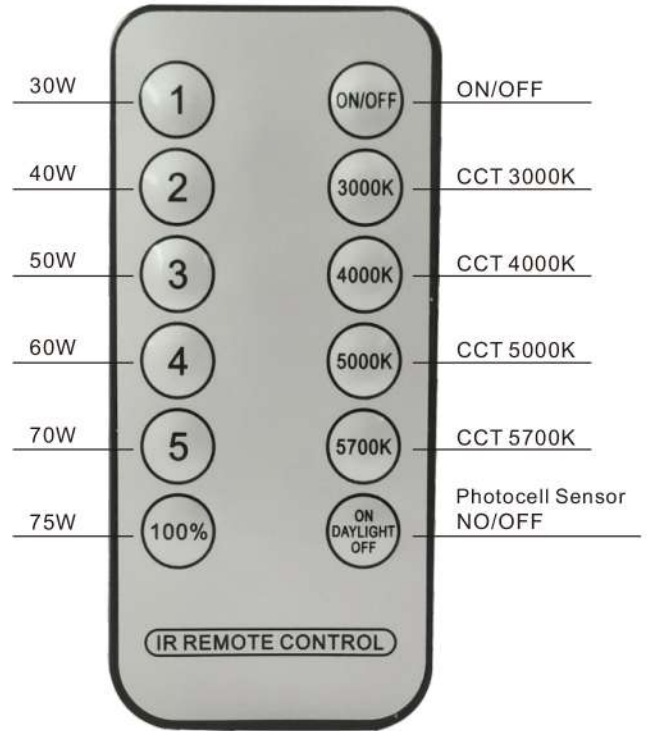

Pole mounting

- Turn off the power before installation.
- Wiring right in the wiring box ("Black" is connected to "L", "White" connect to "N", "Green" to "Ground") and set the lamp into the bracket by the hole. (picture1).
- We should fasten the four screws with a hex wrench, and finished (picture2).

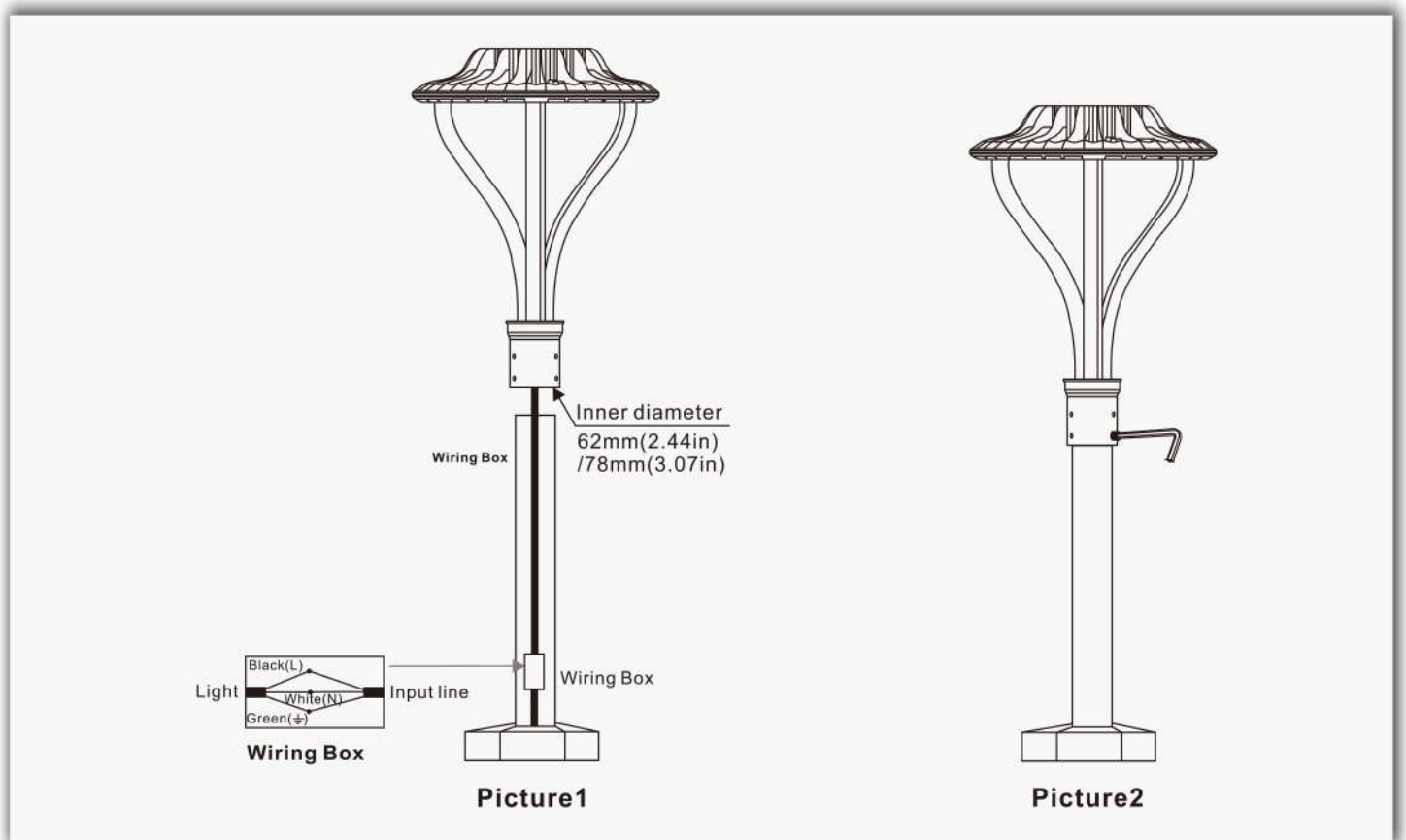

Wall mounting



Optional Accessories

Unit: in(mm)



Motion Sensor

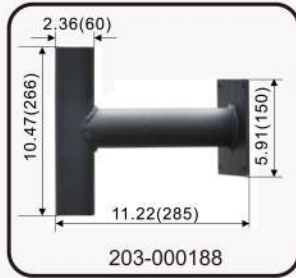

Wall Bracket



With a Baffle

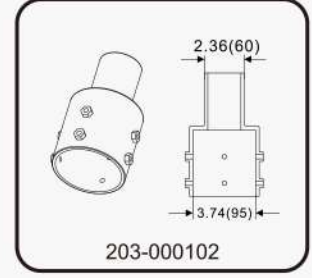

MGD03(2.4" to 3.5" round pole)

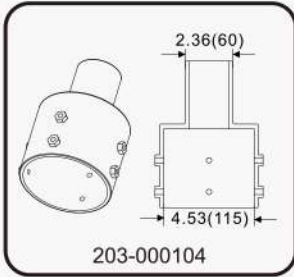

MGD04(2.4" to 3" square or 4" round pole)

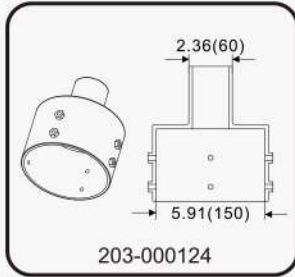

MGD08(2.4" to 4" square or 5.5" round pole)

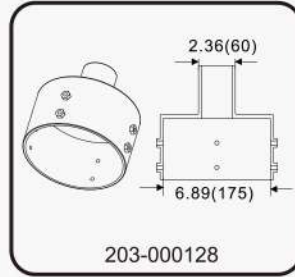

MGD09(2.4" to 6.5" round pole)

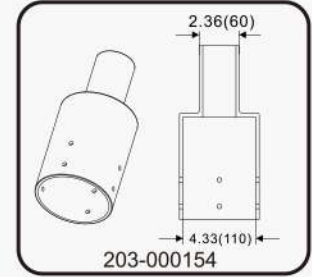

MGD11(2.4" to 3" square or 4" round pole)

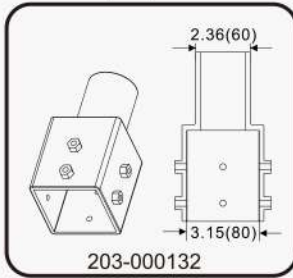

MGD10(2.4" to 3" square pole)

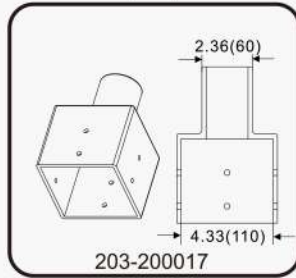

MGD12(2.4" to 4" square pole)

Wiring

(US)

- Connect the black fixture lead to the (+) LINE supply lead.
- Connect the white fixture lead to the (-) COMMON supply lead
- Connect the green Ground wire from fixture to supply ground.
- Connect the purple fixture lead to the (+) dimmer.
- Connect the gray fixture lead to the (-) dimmer.

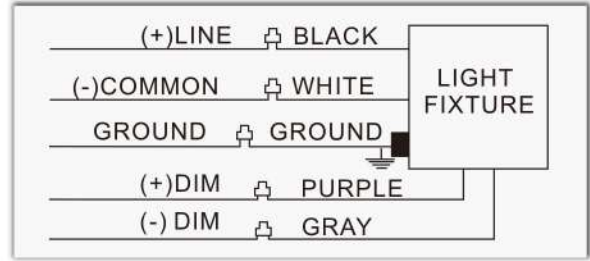

(EU)

- Connect the brown fixture lead to the (+) LINE supply lead.
- Connect the blue fixture lead to the (-) COMMON supply lead
- Connect the yellow /green Ground wire from fixture to supply ground.
- Connect the purple fixture lead to the (+) dimmer.
- Connect the gray fixture lead to the (-) dimmer.

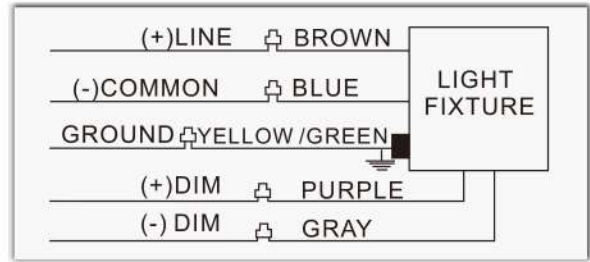

LUMINOUS INTENSITY DISTRIBUTION

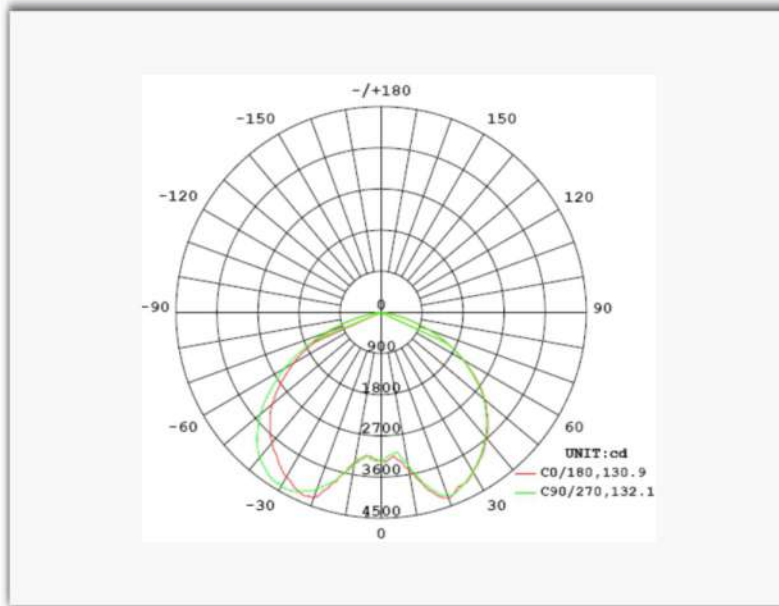

PACKING INFO

Item	Packaging	Carton Size(mm) (L*W*H)	N.W	G.W	Volume weight
Lamp	1pc/CTN	17.3"X15.0"X7.9" 440*380*200mm	11.0 lbs 5.0kg	13.9 lbs 6.3kg	15.4 lbs 7.0kg
Wall bracket	1pc/CTN	14.2"X10.4"X7.3" 360*265*185mm	5.1lbs 2.3kg	8.2 lbs 3.7kg	10.2 lbs 4.6kg